



Wireless Gateway

Model WDHA-12R

Operating Instructions and Owner's Manual

Connects Key Chain and Keypad Remotes to your HomeSettings System

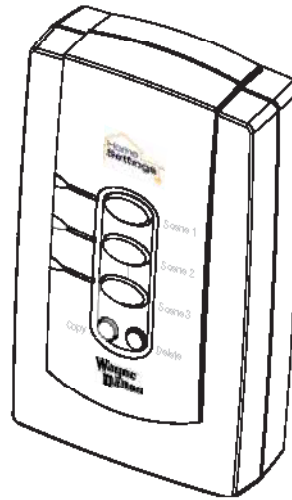

This product is compatible with other Z-Wave™ enabled products

Thank you for purchasing the WDHA-12R HomeSettings Wireless Gateway. HomeSettings products by Wayne-Dalton allow you to control your home by remote control. You can create a complete Home Control and Access Network by combining your Wireless Gateway with other HomeSettings products. Indoor and outdoor lighting, security systems, garage door openers, and thermostats are just a few of the items you can easily control with additional HomeSettings products.

Your new Wireless Gateway is compatible with the complete range of Z-Wave™ enabled HomeSettings products. Furthermore, other Z-Wave™ enabled modules regardless of brand will also work with your Wireless Gateway. Please consult with your module supplier for more details.

Home Control Basics

HomeSettings products will allow you to easily control multiple devices in a home with the push of a button in what is known as a "scene". Turning on all of the lights as you come home is an example of a scene. Dimming lights and closing your curtains to watch TV, it's also a scene.

Visit www.wayne-dalton.com/access to get ideas on how to create scenes with your Wireless Gateway and other Z-Wave™ enabled HomeSettings products.

PACKAGE CONTENTS

Instruction Manual



WDHA-12R Wireless Gateway



Table of Contents

Package Contents	1
Glossary/Basics	2 - 3
Set-up	4 - 6
Placement/Operation	7 - 8
Advanced Features	9 - 13
Troubleshooting	14 -16
Regulatory Compliance.....	18

Look for the **Quick Start** symbol for basic instructions.

GLOSSARY

Copy – See Replicate.

Delete – Erase a transmitter, a Z-Wave™ module or scene information from Controller. Also known as Exclude.

Device – Any item that is connected to a module (for example, lamps).

Exclude – Remove a module, transmitter, or scene from the controller.

Include – Add a module to the controller.

Module – Any HomeSettings or Z-Wave™ product that is controlled with a HomeSettings or Z-Wave™ remote controller. A module can be part of more than one scene.

Network – A collection of Z-Wave™ modules controlled by primary and secondary controllers operating on the same system. A network has its own unique identification code for security.

Operator – Garage door opener or garage door operator.

Primary Controller – The first controller used to set up modules in a network.

NOTE: Only the Primary Controller can be used to include or delete modules from a network. It is recommended that you mark the primary controller in the network for ease in modifying the network.

Remote Control -- Garage door opener transmitter (also see Transmitter).

Replicate – Copy information from one controller to another.

Scene – A scene is a series of Z-Wave™ modules programmed to activate to a specific level (on, off or dim) with the push of a button on a controller. The Wireless Gateway can control 3 scenes.

Secondary Controller – A controller containing a copy of the network information that is created FROM the primary controller. Secondary controllers cannot include or delete modules to the network.

Transmitter – Garage Door Opener transmitter.

Wireless Gateway Basics

The Wireless Gateway, by acting as a “bridge” between standard remote controls (in-vehicle mounted, keypad or key chain) and your garage door opener, allows you to open/close your garage door and activate a multitude of Z-Wave™ enabled modules from your car using a single remote control.

Additionally you can activate Z-Wave™ scenes and open/close your garage door from outside your house with a PIN keypad (wireless keyless entry). The Wireless Gateway will accept a different PIN for each scene you want to trigger. Placing a PIN keypad on a deck or patio is a convenient way to control your deck, outdoor and landscape lighting. Simply create a scene with the Wireless Gateway and then activate the scene with the PIN keypad.

The Wayne-Dalton key chain remote control can be carried or worn as a pendant to activate scenes inside or outside the home. In cases where more than three scenes are required, simply add additional Wireless Gateway modules to your network.

Wireless Gateway Basics (continued)

The Wireless Gateway communicates with your remote controls and Z-Wave™ modules using radio signals. Large metal objects, house wiring, walls, furniture, refrigerators, microwaves and similar items, may interfere and reduce the range of your unit. To maximize the range from the transmitter in your car to the Wireless Gateway, plug the unit into an outlet with the shortest line of sight to your vehicle, as you approach your home.

A Z-Wave™ network is a collection of Z-Wave™ modules in a mesh type of network. Each Z-Wave™ module, regardless of manufacturer, communicates with all the other modules within its range to route and repeat the signals from one device to the next, thus creating a highly robust network transmission throughout the home.

A Z-Wave™ network can have only one primary controller. The primary controller establishes the network security to ensure your network will not operate your neighbor's network and vice-versa. It is a good practice to label and protect your primary controller since it is the only Z-Wave™ controller that can add more modules to your network. It is easy to add secondary controllers as your network grows.

For more tips and great ideas on how to use and expand your Wireless Gateway please visit our website, www.wayne-dalton.com/access.

Programming a Z-Wave™ Scene

Use this procedure to add a Z-Wave™ module to a Wireless Gateway scene button.

If you have an existing Z-Wave™ network then you must first copy the network information from the existing primary controller to the Wireless Gateway. First, follow the step titled “Copy Scenes from Primary Controller to Gateway” (page 11) to copy the existing network information, then follow the procedure below.

Tip: Scenes can be programmed to turn all modules on, off, dim or a combination of on, off and dim.

NOTE: Perform this procedure while the Wireless Gateway is battery powered only. Do not plug the Wireless Gateway into AC power to program.

1. On the Wireless Gateway, Press and Hold the Scene button you wish to program, (either Scene 1, 2 or 3.) The LED on the Wireless Gateway will turn on immediately, then turn off, then turn on again.
2. While holding the Scene button, Press and release the OPERATE button on the Z-Wave™ module you wish to add to a scene.

The LED on the Wireless Gateway will flash three (3) times quickly to indicate the programming is successful. Do not release the Scene button until you see the LED's flash (30 second max wait.)

While holding the Scene button, Press the OPERATE button on the Z-Wave™ module to set the dim level or the ON/OFF state for relay type devices.

3. Release the Scene button on the Wireless Gateway.

Note: You may add multiple modules to each scene button on the Wireless Gateway.

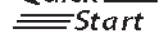
Quick 
Start 

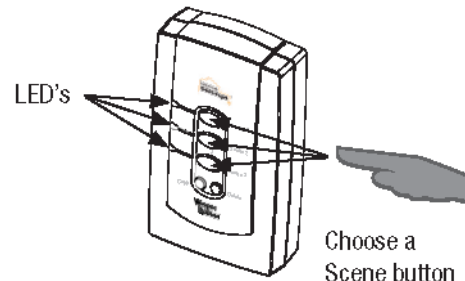

Press and Release the PROGRAM button on the Module

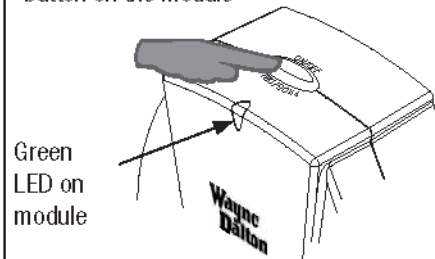

Manually Activating a Scene

Use the following procedure to activate a programmed scene using the buttons on the Wireless Gateway.

1. Momentarily Press and release the desired Scene button (1,2 or 3) on the Wireless Gateway.

Quick 
Start 

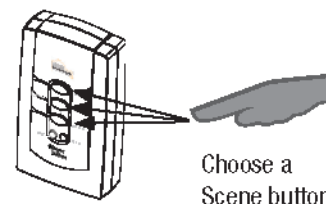

Programming to a Remote Control transmitter

Quick Start

Use the following procedure to teach a hand held remote control transmitter button to a scene button. This procedure is also used to reassign a remote control transmitter button to a different scene button.

1. Press and Hold the scene button you wish to program, either Scene 1, 2 or 3, until the LED turns off, then immediately release the scene button.

2. Press and hold the desired remote control transmitter button.

The LED on the Wireless Gateway will flash three (3) times quickly to indicate the programming is successful.

3. Release the remote control transmitter button.

Note: During set-up the Wireless Gateway will stay active for 10 seconds after programming to allow for testing the scene. After 10 seconds you must either plug the unit into an AC outlet or push one of the three scene buttons to reactivate it for an additional 10 seconds.

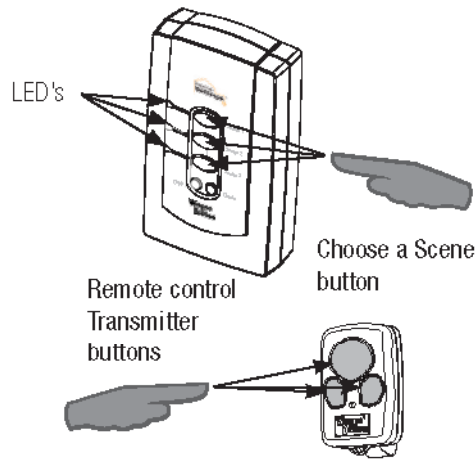

Programming to In-Vehicle Mounted Remote Control transmitters

Quick Start

Car2U™ In-vehicle transmitters:

Use this procedure to teach Car2U™ button 3 to a scene button. This procedure can also be used to reassign Car2U™ buttons to a different scene button.

Note: To Program Car2U™ buttons 1 or 2 to a scene button, see your vehicle owner's manual for instructions on programming with rolling code receivers to change Car2U™ buttons 1 or 2.

1. **Do not plug the Wireless Gateway into AC power to program.**

Press and Hold scene button you wish to program, either Scene 1, 2 or 3, until the LED turns off, then immediately release the scene button.

2. Press and hold Car2U™ button 3.

The LED on the Wireless Gateway will flash three (3) times quickly to indicate the programming is successful.

3. Release the transmitter button.

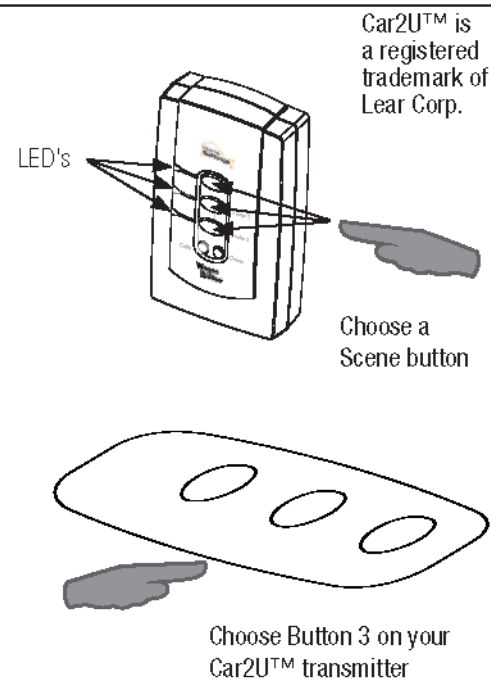

Programming to In-Vehicle Mounted Remote Controls (continued)

Homelink® in-vehicle transmitters:

Use this procedure to teach a Homelink® button to a scene button. This procedure can also be used to reassign a Homelink® button to a different scene button.

1. Place the Wireless Gateway within 3 inches of the Homelink® transceiver. **The Wireless Gateway must NOT be plugged into an AC outlet for this operation.**
2. Press and hold the desired Homelink® button. The Homelink® LED will either flash slowly or light on solid.
3. On the Wireless Gateway, press and hold the Scene 1 button. The LED on the Wireless Gateway will turn on immediately, then turn off, then turn on again. This is normal. Keep holding both buttons simultaneously.
4. Keep holding both buttons until the Homelink® transceiver LED flashes rapidly or turns off completely. (This process may take up to 60 seconds.)
5. Release the Wireless Gateway Scene button and the Homelink® transceiver button.
6. On the Wireless Gateway, press and hold the Scene button you wish to program; either Scene 1, 2 or 3 until the LED turns off, then immediately release the Scene button.
7. Press and hold the desired programmed Homelink® button from Step 2.

The LED on the Wireless Gateway will flash three(3) times quickly to indicate the programming is successful.

Quick 
Start 

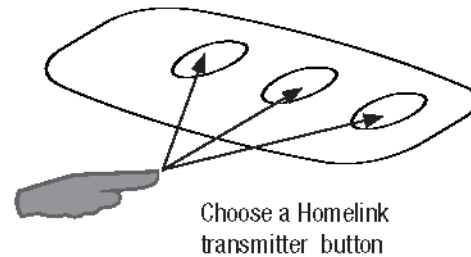
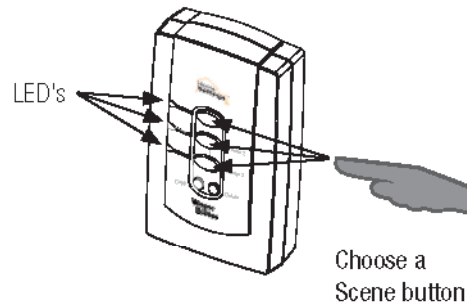

The Homelink logo and trademark are the property of Johnson Controls, Inc.

Placement of Gateway

Locate the Wireless Gateway in your home in a convenient electrical outlet which will give you the best performance for receiving your in-vehicle remote control transmitter and for transmitting the signal to other modules.

For many users the best location is in the front corner of the home closest to their most common approach direction which may be a dining room, living room or bedroom. The position is indicated in the drawings with a "Star" symbol.

Do not place the Wireless Gateway near large metal objects such as refrigerators and freezers or a permanently parked car that could block the radio signal.

Note: The Wireless Gateway antenna should be straight and positioned in the most vertical position possible.

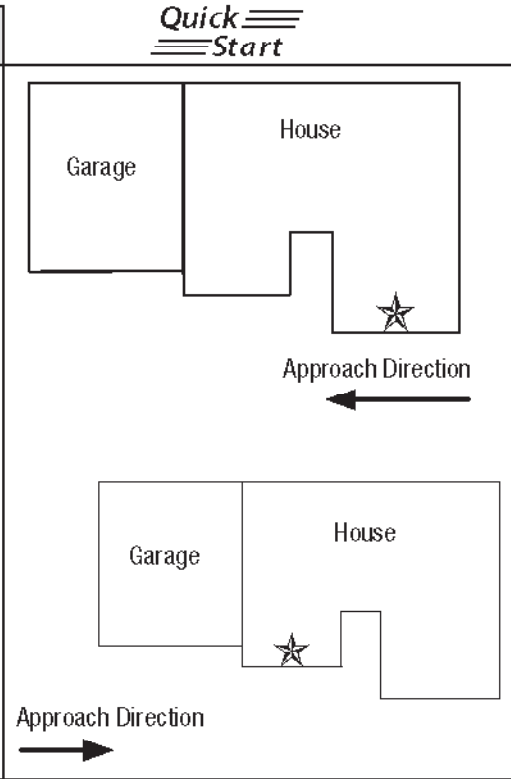

Operation

Use the following procedure to activate a programmed scene.

1. Plug the Wireless Gateway into an appropriate AC outlet
2. Press and release the desired scene button on the Wireless Gateway, either 1, 2 or 3.

OR

Activate Wireless Gateway scenes from your hand held remote control transmitter or in-vehicle mounted remote control transmitter by pressing the transmitter button that corresponds to the scene to which it was programmed. (See page 5.)

Note: By default, scene 3 is pre-programmed to ALL OFF unless Z-Wave™ modules have been added to Scene 3, in which case only the added modules will activate.

Tip: Scenes can be programmed to turn all modules ON, turn all modules OFF, or a combination of ON and OFF.

Note: A maximum of 12 remote control transmitters can be programmed to the Wireless Gateway.

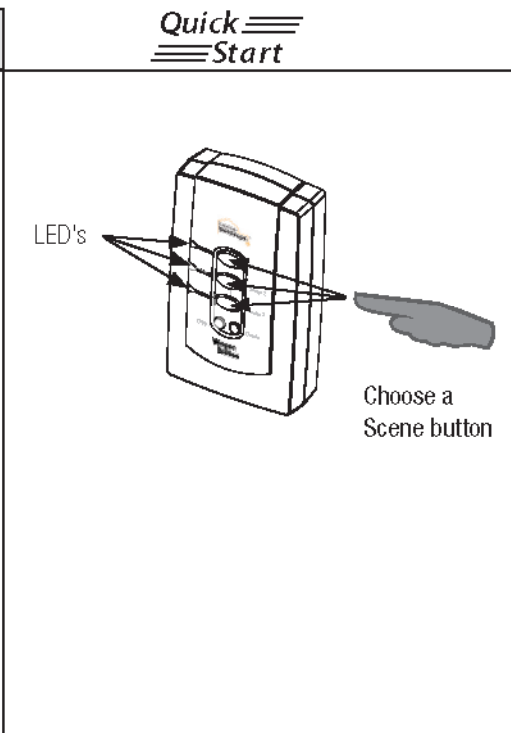

Examples of Scenes	
<p>The following examples describe how your Wireless Gateway can be used. For more ideas, please visit our website at www.wayne-dalton.com/access.</p> <p>1. Approaching your home in your car, you wish to turn on the outside lights near the garage, front door and rear door, as well as lamps in the kitchen and family room. Wireless Gateway Scene 1 can be programmed to turn all of these lights ON. To operate Scene 1 from your car, you will also need to program one button of the remote control transmitter located in your car to Scene 1.</p> <p>2. In your car and leaving your home you wish to turn off the outside lights near the garage, front door and rear door, as well as interior lights. Wireless Gateway Scene 2 can be programmed to turn all of these modules OFF. To operate Scene 2 from your car, you will also need to program one button of the remote control transmitter located in your car to Scene 2.</p> <p>3. Noises outside your home awaken you during the night. Scene 3 is programmed to turn on only the outside lights. You can turn on Scene 3 with your Key chain Remote Control from your bedroom to illuminate the area and scaring off any potential intruders.</p> <p>4. Lights out! You have tucked your 2 children in bed and one has your permission to read for 15 minutes while the other has your permission to watch TV for 15 minutes. After 15 minutes you want to turn off their lights and TV. Scene 2 is programmed to their bedroom lights, lamps and to a TV in the child's room. Using your Key chain Remote Control you can turn their lights and TV off.</p>	<p>Examples require the following modules:</p> <p>1 - Wireless Gateway, WDHA-12R 1 - Key chain Remote Control, 3150R (or in-vehicle transmitter) 3 -Dimmer Switch Module HA-06WD (for each light switch) 2 - Lamp Module, HA-03WD (for lamp in kitchen and family room)</p> <p>1 - Wireless Gateway, WDHA-12R 1 - Key chain Remote Control, 3150R (or in-vehicle transmitter) 3 -Dimmer Switch Module HA-06WD (for each light switch) 2 - Lamp Module, HA-03WD (for lamp in kitchen and family room)</p> <p>1 - Wireless Gateway, WDHA-12R 1 - Key chain Remote Control, 3150R 3 -Dimmer Switch Module HA-06WD (for each light switch)</p> <p>1 - Wireless Gateway, WDHA-12R 1 - Key chain Remote Control, 3150R 2 - Lamp Module, HA-03WD (for lamps in each child's room) 1 - Appliance Module HA-02WD (for the TV)</p>

**Programming PIN Keypad Transmitters
(Keyless Entry)**

Use the following procedure to teach a PIN keypad transmitter to a scene button.

1. On the Wireless Gateway, press and hold the scene button you wish to program, either scene 1, 2 or 3, until the LED turns off, then immediately release the scene button.
2. Turn the PIN Keypad transmitter on, if required, and type in your desired PIN Code (Be sure you press the required number of digits for your PIN keypad device, for example the KEP2 requires 4 digits and the Model 3966 (KEP3) requires 5 digits.)

The LED on the Wireless Gateway will flash three (3) times quickly to indicate the programming is successful.

To Operate the scene from the PIN keypad transmitter, turn the device on and type in the PIN code for the scene you wish to activate.

Note: One PIN Keypad transmitter can operate multiple Wireless Gateway modules.

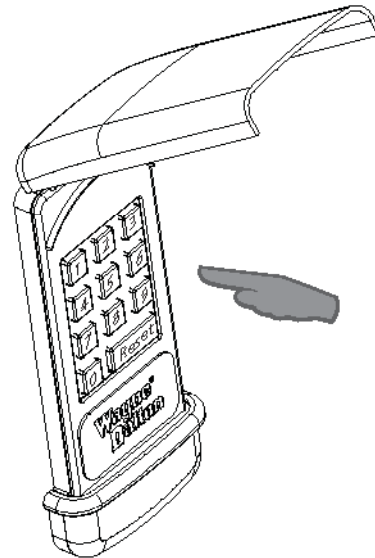
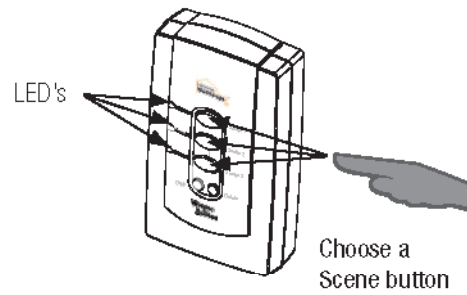

KEP2 PIN Code Keypad Transmitter

Remove Transmitter from Scene

Use this procedure to remove a hand-held remote control transmitter or in-vehicle mounted transmitter from a Wireless Gateway scene button.

1. Press and release the DELETE button on the Wireless Gateway.
All three (3) LED's on the Wireless Gateway will turn on.
2. Within five (5) seconds, press and release the scene button you wish to disconnect from on the Wireless Gateway.
The selected scene LED will stay lit for 5 seconds and the other two will turn off.
3. Within five (5) seconds, press the in-vehicle transmitter or hand-held remote control transmitter button you wish to disconnect from the Wireless Gateway.
The LED for the selected scene on the Wireless Gateway will flash three (3) times quickly to indicate a successful disconnect.

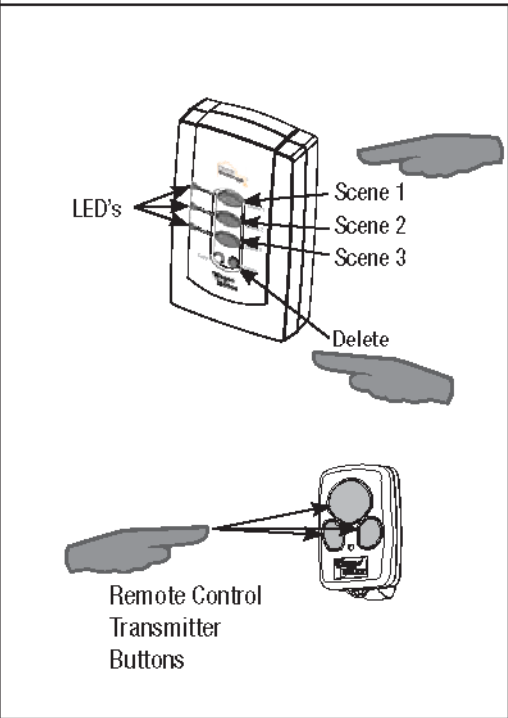

Remove Z-Wave™ module from a Scene

Use the following procedure to remove a single Z-Wave™ device from a programmed scene. The Wireless Gateway must not be plugged into AC outlet for this operation.

1. Press and release the DELETE button on the Wireless Gateway.
All three (3) LED's on the Wireless Gateway will turn on.
2. Within 5 seconds, press the scene button that is associated with the device you want to remove.
The selected scene LED will stay lit for 5 seconds and the other two will turn off.
3. Press and release the Program button on the Z-Wave™ device you wish to remove.
The LED on the Wireless Gateway will flash three (3) times quickly to indicate the removal was successful.

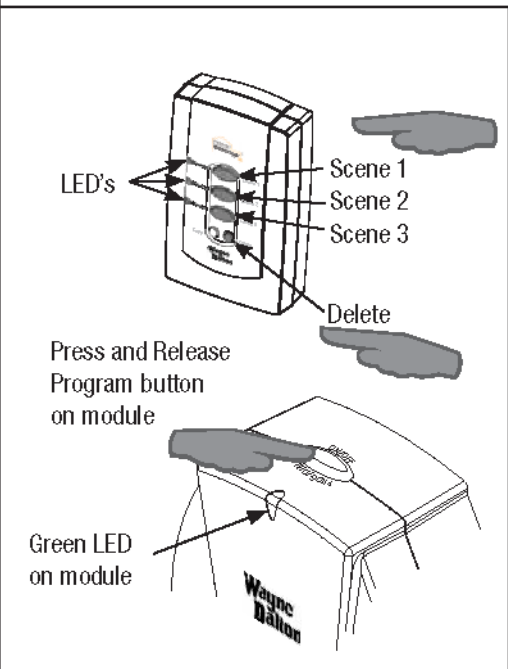

Copy Scenes from Primary Controller to Gateway

Use the following procedure to copy scene information from a Primary Controller. This procedure is used when you are setting up the Wireless Gateway to an existing Z-Wave™ network.

Note: This procedure can also be used to make the Wireless Gateway assume the primary controller role. Please refer to your other controller's instructions for information on how to transfer Primary Controller Status (via controller shift if supported) to a new controller.

1. Place Wireless Gateway within 6 feet of the primary controller.
2. Press and Hold the COPY and Scene 1 button simultaneously for 3 seconds on the Wireless Gateway.

After 3 seconds, the LED's on the Wireless Gateway will turn on. Immediately release the COPY button. The Wireless Gateway will flash all LED's.

3. Within 20 seconds, start the "SEND" function from the primary controller. Consult the owner's manual for your primary controller for specific information on the "SEND" (Replicate) command.

The LED's on the Wireless Gateway will continue to flash during the COPY (replication) process. Once the LED's turn off COPY is complete.

The Wireless Gateway is now a secondary Controller (or primary controller if controller shift is requested.)

Note: The process outlined above copies the network and scene information to your Wireless Gateway. If you are planning to create totally new Scenes with Wireless Gateway you must erase all copied scene information first. See "Deleting the Contents of a Single Scene" page 12.

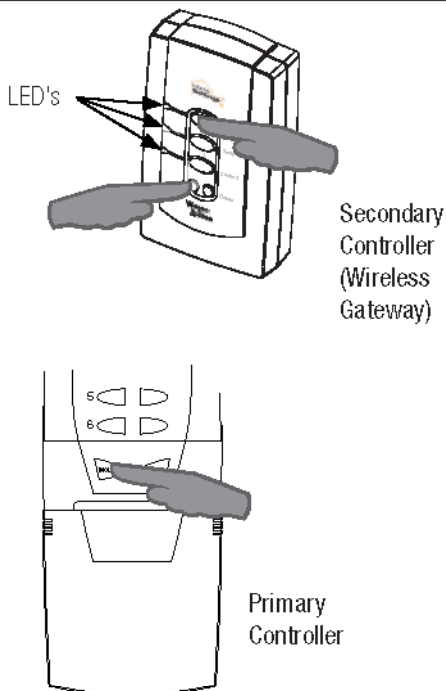

Copy Scenes from Gateway to Secondary Controller

Z-Wave™ technology allows you to create multiple duplicate controllers. The duplicate controllers become secondary controllers in your existing network. The following procedure is used to send all network and scene information to another Controller from the Wireless Gateway. The Wireless Gateway must be the primary controller.

1. Place Wireless Gateway within 6 feet of the secondary controller.
2. Place the secondary controller into “Receive Replication” or “Copy From” mode. (See your controller instructions for more details.)
3. Press and hold the COPY button on the Wireless Gateway for 3 seconds . The LED’s on the Wireless Gateway will flash rapidly (approximately 1 flash every 1/2 second) during the operation.

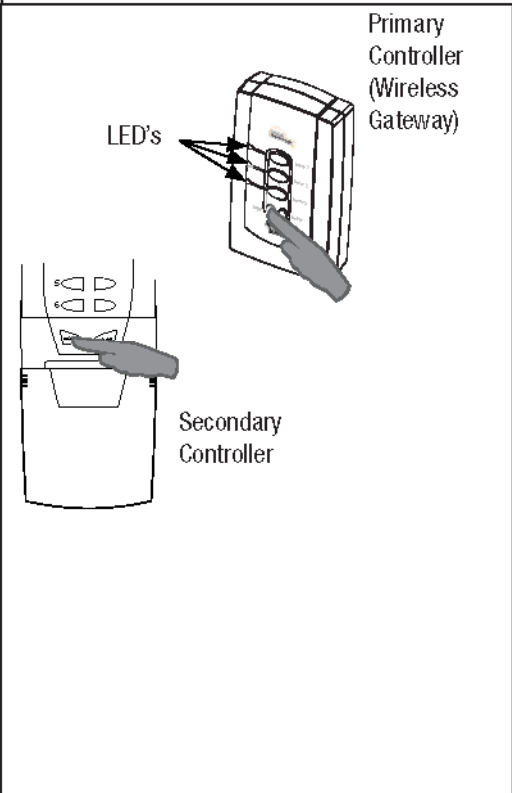

Deleting the Contents of a Single Scene

Use the following procedure to remove all Z-Wave™ modules from a single scene on the Wireless Gateway. This will delete all modules and remote control transmitters from the chosen scene.

1. Simultaneously press and hold the DELETE and the scene button you wish to reset, either scene 1, 2 or 3 on the Wireless Gateway.

After 10 seconds the LED on the Wireless Gateway will flash three (3) times quickly indicating the scene was cleared.

2. Release the buttons.

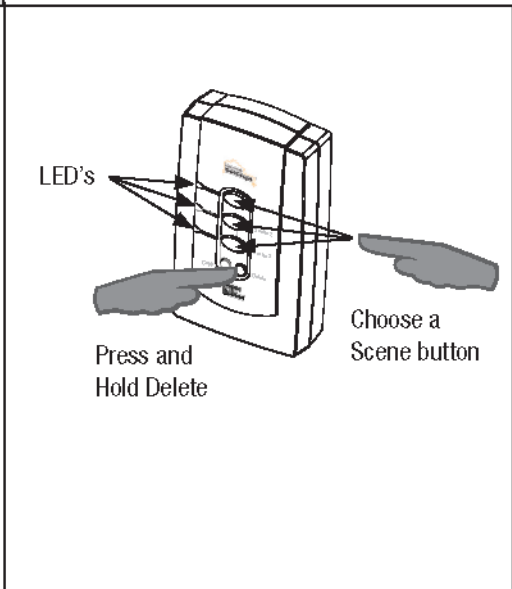

Resetting the Gateway

Use the following procedure to factory reset the Wireless Gateway. This procedure will destroy a network if the Wireless Gateway is the primary controller.

Note: When resetting a Wireless Gateway that is a primary controller, each module within the network must be individually reset.

1. Simultaneously press and hold the Scene 1, 2 and 3 buttons on the Wireless Gateway.

After 3 seconds the LED's on the Wireless Gateway will flash quickly indicating the memory was cleared.

2. Release the buttons.

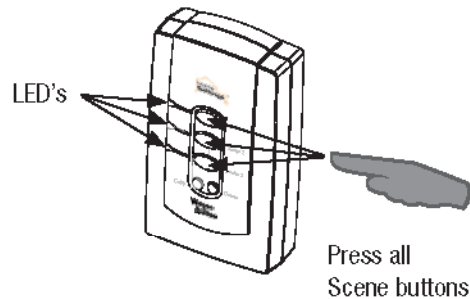

Remove a Z-Wave™ Module from the Network

Use the following procedure to permanently remove a single Z-Wave™ module from the Network. The Wireless Gateway must be the primary controller for the network.

Note: Use this feature only if you plan to permanently remove a module from the network. Make sure you delete the module from all scenes in all secondary controllers BEFORE using this procedure.

1. Press and **HOLD** the DELETE button on the Wireless Gateway until all 3 LED's turn on then release.
2. Press and Release the PROGRAM button on the device you wish to remove. The LED's on the Wireless Gateway and Z-Wave™ module will flash to indicate a successful operation. This step must be done within 5 seconds of completing step 1.

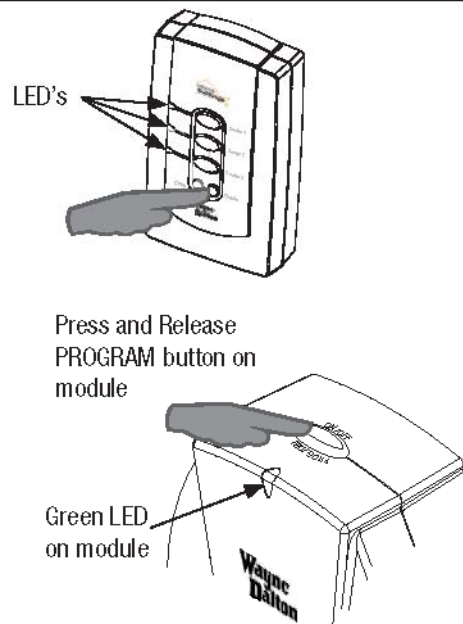

Troubleshooting	
<p>Problem: Wireless Gateway LED's remain lit for a long period of time when deleting or programming.</p>	<p>Solution: Momentarily plug the Wireless Gateway into an electrical outlet to reset the device to normal operating mode.</p>
<p>Problem: Modules can not be removed from the Wireless Gateway.</p>	<p>Solution: The Wireless Gateway is a secondary controller in the network, only Primary controllers can be used to add or delete modules to a network.</p>
<p>Problem: • How do I determine if my Wireless Gateway is a primary or secondary controller?</p>	<p>Solution: Press and hold the DELETE button for 3 seconds, if all 3 LED's turn on the Gateway is a primary controller, if the LED's do not turn on, the Gateway is a secondary controller. Do not manually operate any Z-Wave™ modules during this test.</p>
<p>Problem: •When activating a Scene, the modules do not turn on quickly and/or behave erratically.</p>	<p>Solution A: This is a common when there is a burned out bulb in one or more nodes. Replace the bulb.</p> <p>Solution B: If the primary controller was reset and all of the modules and secondary controllers in the network were not reset at the same time, then the newly created network could exhibit this behavior. The solution is to reset the primary controller, all secondary controllers and all modules in the network and then set up a new network.</p>

Troubleshooting	
<p>Problem:</p> <ul style="list-style-type: none"> • No Scenes activate when I use a Wireless Key Chain transmitter to activate scenes, however pressing scene buttons on the Wireless Gateway work fine. <p>Problem:</p> <ul style="list-style-type: none"> • The Wireless Gateway will not program to a Z-Wave™ enabled module. 	<p>Solution:</p> <p>The Wireless Gateway must be plugged into an AC outlet for power. Battery power is for programming purposes only and has an automatic time out feature.</p> <p>Solution A:</p> <p>The Wireless Gateway must be within 6 feet of any Z-Wave™ module during programming.</p> <p>Solution B:</p> <p>Be certain you are following the correct programming approach. Programming Z-Wave™ modules requires that you Press and Hold the scene button you wish to program on the Wireless Gateway until the LED turns on, off and then on again, then Press and Release the Z-Wave™ module program button on the module you want to associate with a scene. Followed by releasing the Wireless Gateway scene button.</p> <p>Transmitters (such as Car2U™, KEP2, 3966 (KEP3) and 3150R)) require that you Press and Hold the Scene button on the Wireless Gateway module until the LED turns on, then off, then release the Scene button, followed by a Press and Release of the transmitter button you wish to program.</p> <p>Solution C:</p> <p>If your module is part of an existing network you must first copy the scene information from your primary controller to the Wireless Gateway. See “Copy Scenes from Primary Controller to Gateway”, page 11.</p> <p>Solution D:</p> <p>If your module previously belonged to another network or you are replacing a lost or broken primary controller then you must first delete the module from the old network prior to adding it to the new primary controller. See “Remove a Z-Wave™ Module From the Network”, page 13.</p>

Troubleshooting	
<p>Problem:</p> <ul style="list-style-type: none"> • A previously programmed remote control transmitter no longer works. 	<p>Solution:</p> <p>The Wireless Gateway holds a maximum of 12 remote control transmitters, after which the last one is replaced.</p>
<p>Problem:</p> <ul style="list-style-type: none"> • I activated a scene but wish to abort the execution of that scene before it is complete. 	<p>Solution:</p> <p>Using a remote control transmitter such as the Car2U™, Homelink®, 3150R, KEP2, or 3966 (KEP3), by pressing any previously programmed scene other than the one you just activated, you will abort the current scene.</p>
<p>Problem:</p> <ul style="list-style-type: none"> • The range of the remote control transmitter I use to activate the Wireless Gateway is reduced. 	<p>Solution A:</p> <p>Your remote control transmitter may need fresh batteries, replace if necessary.</p> <p>Solution B:</p> <p>Check to be sure the Wireless Gateway antenna is in the most vertical position.</p> <p>Solution C:</p> <p>Check the area around the Wireless Gateway for any large metal objects which could be interfering with the antenna reception.</p>
<p>Problem:</p> <ul style="list-style-type: none"> • Modules take a long time to respond to a command 	<p>Solution:</p> <p>Check that all Z-Wave™ modules are on and working, the Wireless Gateway may be searching for a module that may have been disconnected, moved, or has failed. Check for burned out light bulbs in lamps controlled by Z-Wave™ modules and replace if necessary.</p>
<p>Problem:</p> <ul style="list-style-type: none"> • The Wireless Gateway works fine when plugged into an AC outlet but when used in hand held mode nothing works. <p>OR</p> <ul style="list-style-type: none"> • The Wireless Gateway behaves erratically and/or appears to lock up when creating scenes or removing modules from scenes or from the network. 	<p>Solution:</p> <p>Wireless Gateway battery needs to be replaced. Open unit with a small philips head screwdriver and replace the 9V battery, then reassemble the Wireless Gateway. WARNING: DO NOT PLUG THE WIRELESS GATEWAY INTO AC POWER WHEN THE COVER IS REMOVED.</p>

This page intentionally left blank.

Covered by one or more of the following Patents D413,055; D413,579; D413,867; D421,031; D472,568; D472,910; D473,573; D473,574; D505,393; 5,929,580; 5,931,212; 6,078,249; 6,161,438; 6,145,570; 6,164,014; 6,325,134; 6,326,751; 6,326,754; 6,401,792; 6,561,255; 6,561,256; 6,568,454; 6,588,156; 6,605,910; 6,667,591; 6,739,372; 6,845,804; 6,851,465; 6,873,127; 6,880,609; 6,903,650. Other US and Foreign Patents pending.

Z-Wave™ is a trademark of Zensys Corp.

FCC and IC Statement

FCC Regulatory Information:

NOTE: This equipment has been tested and found to comply with the limits for a Class B digital device, pursuant to Part 15 of the FCC Rules. These limits are designed to provide reasonable protection against harmful interference in a residential installation. This equipment generates, uses, and can radiate radio frequency energy and, if not installed and used in accordance with the instruction, may cause harmful interference to radio communications. However, there is no guarantee that interference will not occur in a particular installation. If this equipment does cause harmful interference to radio or television reception, which can be determined by turning the equipment off and on, the user is encouraged to try and correct the interference by one or more of the following measures:

- a) reorient or relocate the receiving antenna,
- b) increase the separation between the equipment and receiver,
- c) connect the equipment into an outlet on a circuit different from that to which the receiver is connected.

Consult the dealer or an experienced radio/TV technician for help.

IC Regulatory Information:

This Class B digital apparatus meets all requirements of the Canadian Interference Causing Equipment Regulations. Operation is subject to the following two conditions: (1) this device may not cause harmful interference, and (2) this device must accept any interference received, including interference that may cause undesired operation of the device.

Cet appareillage numérique de la classe B répond a toutes les exigences de l'interférence canadienne causant des règlements d'équipement. L'opération est sujette aux deux conditions suivantes: (1) ce dispositif peut ne pas causer l'interférence nocive, et (2) ce dispositif doit accepter n'importe quelle interférence reçue, y compris l'interférence qui peut causer l'opération peu désirée.

WARNING: Changes or modifications to this receiver not expressly approved by Wayne-Dalton Corp. could void the user's authority to operate this equipment.

© Copyright 2006 Wayne-Dalton Corp. Part No. 0001283 Rev A New 10/24/06
 You can reach us Toll Free 1-888-827-3667 for Consumer Assistance
 or online at www.wayne-dalton.com/access